

474

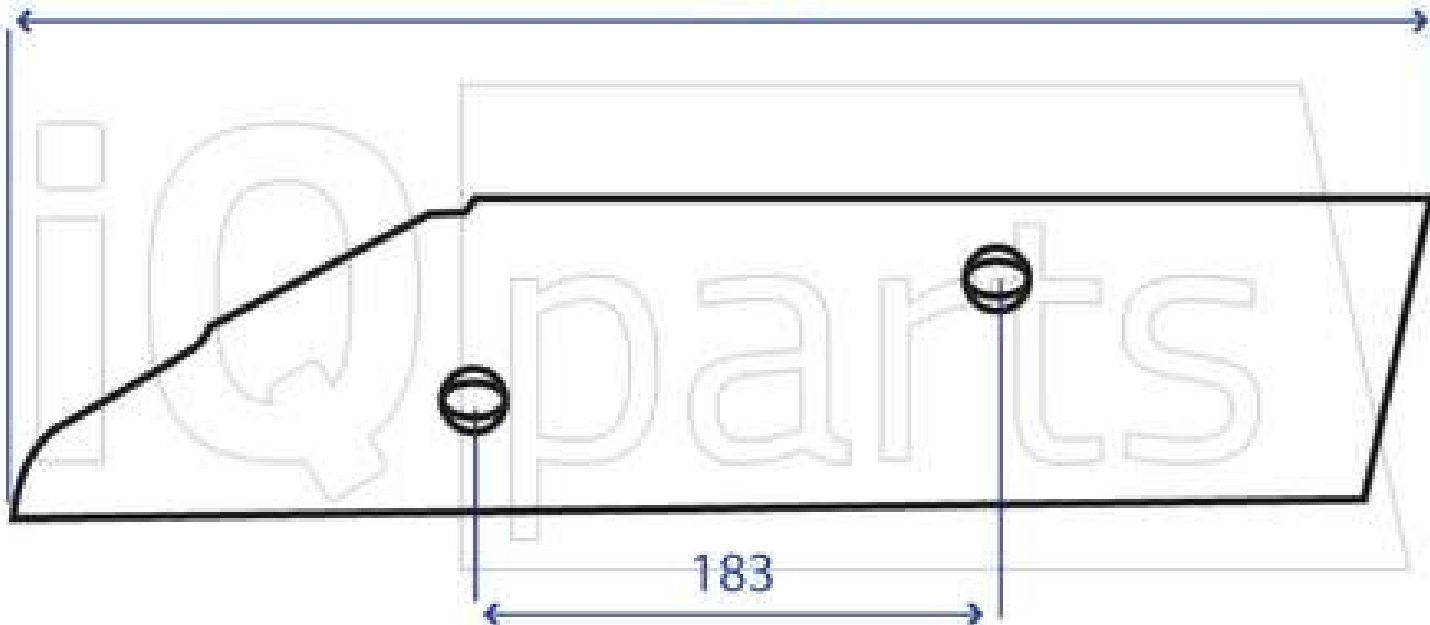

183

278071